



SEAMAX^{series} VL-420W-166M/132

Monocrystalline PERC Module

1928×1038×35 **166×83**
Module dimensions (mm) Cell size (mm)

132 CELL **395-420Wp**
Mono PERC module Power output

1500V DC **20.99%**
Max. system voltage Max. efficiency



KEY FEATURES

- Higher Power Output**
Module power increases by 5-25% generally, bringing significantly lower LCOE and higher IRR. 0-5w positive tolerance output warranty.
- Most Advanced Production Technologies**
Optimize module current profile, improve system-side power generation.
- Multi Busbar Technology**
By improving optical utilization rate, power increases by 2~3% and efficiency increases by 0.4~0.6%.
- PID Resistance**
Excellent Anti-PID performance guarantee via optimized mass-production process and material control.
- Low-light Performance**
Excellent performance in low light.
- Enhanced Mechanical Load**
Certified to withstand: wind load (2400 Pa) and snow load (5400 Pa).
- Durability Against Extreme Environmental Conditions**
High salt mist and ammonia resistance certified by TUV NORD.
- EL Full Inspection**
Dual stage 100% EL Inspection warranting defect-free product.



Comprehensive Products and System Certificates

- IEC61215/IEC61730/IEC61701/IEC62716
- ISO 9001: Quality Management System
- ISO 14001: Environmental Management System
- ISO14064: Greenhouse Gases Emissions Verification
- OHSAS 18001: Occupational Health and Safety Management System

LINEAR PERFORMANCE WARRANTY

12-year product warranty / 25-year linear power warranty

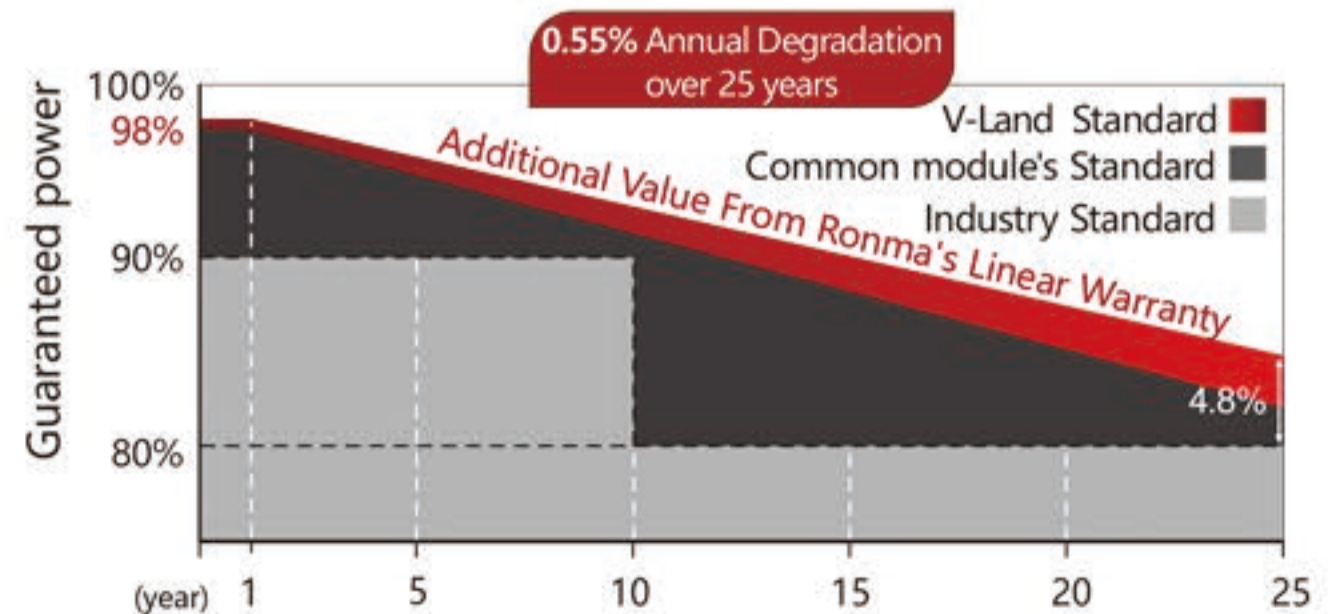



Dimensions of PV Module

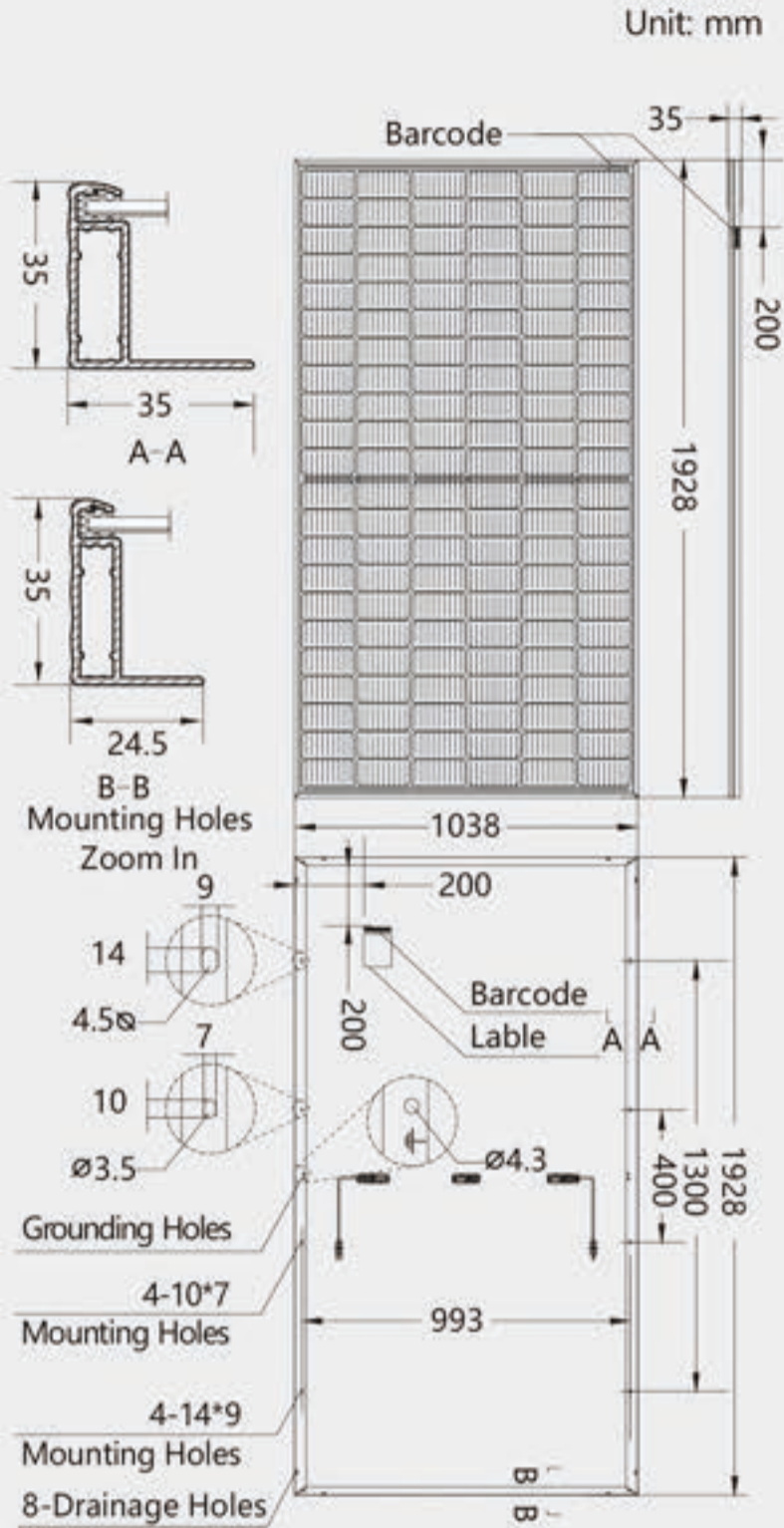

VL-420W-166M/132

I-V characteristics at different irradiances

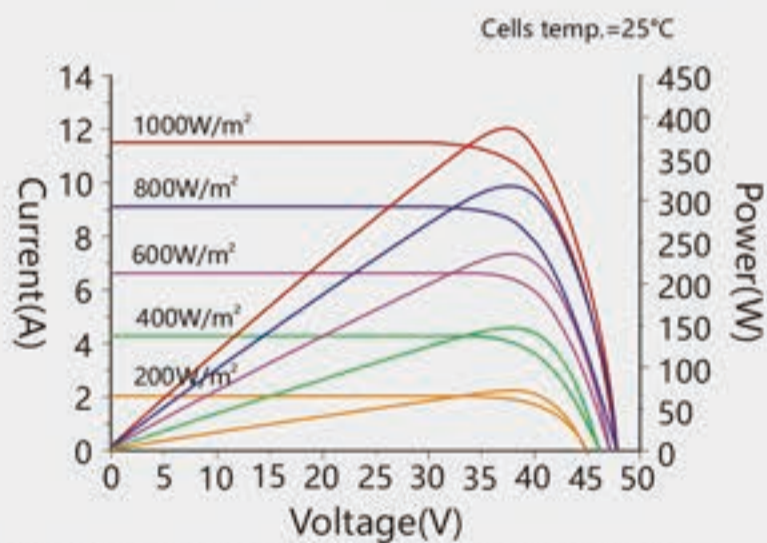

I-V characteristics at different temperatures

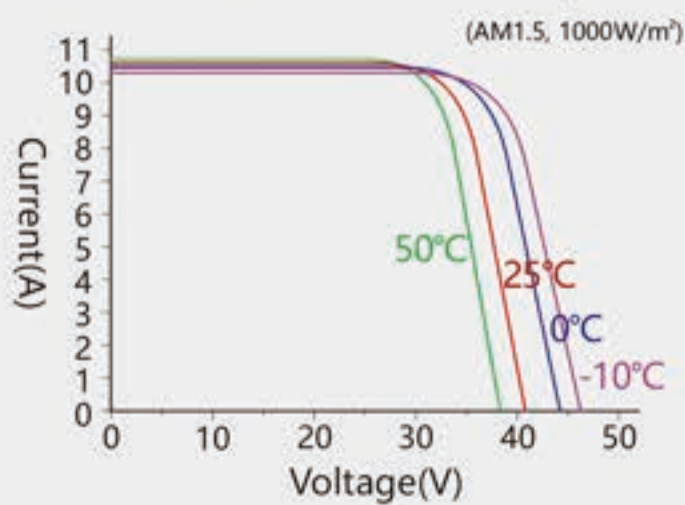

ELECTRICAL DATA(STC)

Model Number	VL-395W-166M/132	VL-400W-166M/132	VL-405W-166M/132	VL-410W-166M/132	VL-415W-166M/132	VL-420W-166M/132
Rated Power in Watts-Pmax(Wp)	395	400	405	410	415	420
Open Circuit Voltage-Voc(V)	44.70	45.00	45.30	45.60	45.90	46.20
Short Circuit Current-Isc(A)	11.24	11.30	11.37	11.45	11.52	11.58
Max. Power Voltage-Vmpp(V)	36.90	37.20	37.50	37.80	38.10	38.40
Max. Power Current-Impp(A)	10.71	10.76	10.81	10.85	10.90	10.95
Module Efficiency(%)	19.74	19.99	20.24	20.49	20.74	20.99

STC: Irradiance 1000W/m², Cell Temperature 25°C, Air Mass AM 1.5,
NOCT: Irradiance at 800W/m², Ambient Temperature 20°C, Wind Speed 1m/s.

MECHANICAL DATA

Solar Cells	Monocrystalline
Cell Size	166mm×83mm
Cell Configuration	132 cells (6×11+6×11)
Module Dimensions	1928×1038×35mm
Weight	22.0kg
Glass	High Transmission, Low Iron, Tempered ARC Glass 3.2mm
Back Sheet	White
Frame	Anodized Aluminium Alloy type 6005 T6, Silver/Black Color
J-box	PV-RM01, IP68, 1500V DC, 3 Diodes
Cables	4.0mm ² , (+) 300mm, (-) 300mm (Connector Included)
Connector	MC4-compatible

TEMPERATURE & MAXIMUM RATINGS

Nominal Operating Cell Temperature (NOCT)	44°C ± 2°C
Temperature Coefficient of Voc	-0.27%/°C
Temperature Coefficient of Isc	0.04%/°C
Temperature Coefficient of Pmax	-0.36%/°C
Operational Temperature	-40°C ~ +85°C
Max. System Voltage	1500V DC
Max. Series Fuse Rating	20A

PACKAGING CONFIGURATION

	40ft (HQ)
Number of Modules Per Container	744
Number of Modules Per Pallet	31
Number of Pallets Per Container	24
Packaging Box Dimensions (l×w×h) (mm)	1960×1130×1180
Box Gross Weight (kg)	680